

Pos. Nr. Pos. no.	Beschreibung Description	Art.-Nr. Art. no.	Preisgruppe Price bracket
1	Zugfeder Draw spring	86208	3
2	GF-Schraube M2x5 Self-tapping screw M2x5	114966	3
3	TS-Windleitbleche, Kesselbod. Part set smoke deflectors, boiler bottom	126577	12
4	TS-Tendertür, Stütze, FH-Rückwand Part set tender door, control cab rear wall	126580	12
5	TS-Kupplungsdeichseln+Stützen Part set coupling reception + support	126583	13
6	TS-Fenster, Lichtleiter, Linse Part set window, light conductor, lens	126584	13
7	TS-Generator, Leitungen Part set generator, lines	126585	6
8	TS-Sandrohre, Ventile m. Handr. schwarz Part set sand pipe, valve w. handwheel black	126586	7
9	TS - Lampen, Pumpen, Steck. Part set lamps, pumps	126593	10
10	TS-Drahtstangen chem.geschw. Part set thread rods black	126629	10
11	TS-für Kessel + Tender Part set for boiler + tender	126596	10
12	Umlauf lackiert Running board coated	129036	13
13	TS-Lok + Tendergewichte Part set loco + tender weight	126606	12
14	Kessel kpl. Boiler ass.	129035	34
15	Führerhaus kpl. Betr.nr. 44 0296-2 Driver's cab ass. loco no 44 0296-2	139996	17
16	Loknummer Betr.nr. 44 0296-2 Loco number 44 0296-2	139995	10

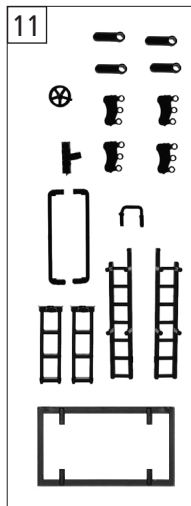

Änderungen in Konstruktion und Ausführung vorbehalten  
We reserve the right to change the construction and specification

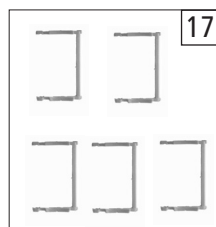
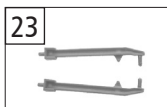
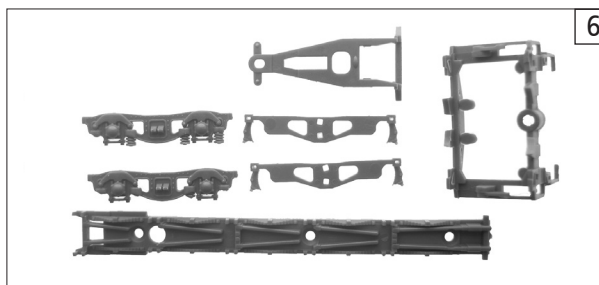
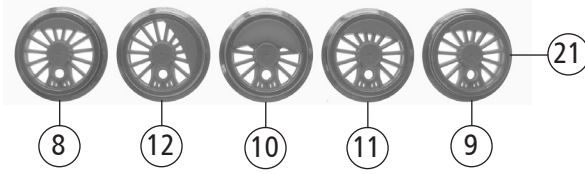
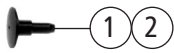
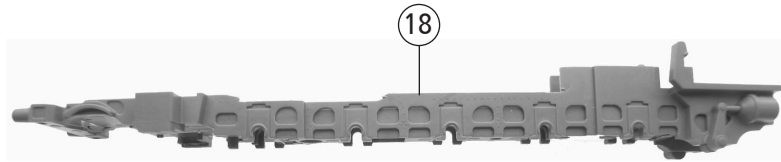
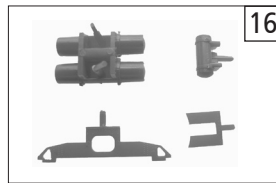
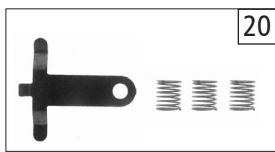
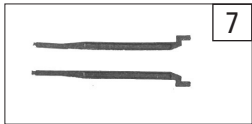
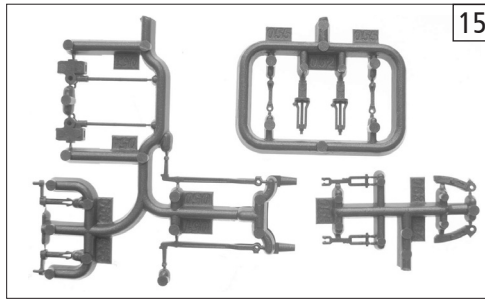
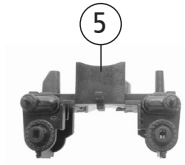
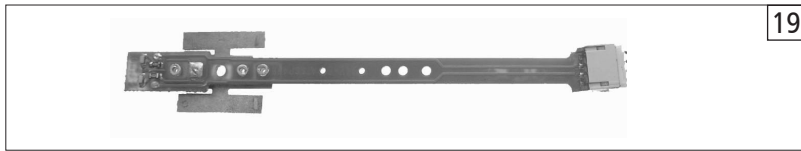

Pos. Nr. Pos. no.	Beschreibung Description	Art.-Nr. Art. no.	Preisgruppe Price bracket
1	Puffer flach Buffer, flat	107658	5
2	Puffer gewölbt Buffer, curved	107659	5
3	SK-Schraube M1,6x5 SK-Screw M1,6x5	115317	4
4	SK-Schraube M1,6x16/6 SK-Screw M1,6x16/6	123585	3
5	Zylinderblock Cylinder block	129029	10
6	TS-Vorlaufgestell, Lokboden, Steuerahmen Part set, bogie, loco bottom, control frame	126581	13
7	Kreuzkopfführung links+rechts Cross-head bearing left+right	126582	9
8	Kuppelradsatz kleines Gewicht o. Haftr. Coupled wheelset small weight w/o trac.tyres	126587	11
9	Kuppelradsatz kleines Gewicht m. Haftr. Coupled wheelset small weight w.trac.tyres	126588	12
10	Treibradsatz grosses Gewicht Driving wheelset big weight	126589	11
11	Kuppelradsatz mittleres Gewicht Coupled wheelset middle weight	126590	11
12	Radsatz mit mittleren versetztem Gewicht Wheelset w. middle shifted weight	126591	12
13	Vorlaufradsatz Pony truck wheelset	126592	9
14	TS-Kuppelstangen Part set coupling rods	126597	15
15	TS-Steuerung Part set reversing gear	126598	10
16	TS-Luftkessel, Stützenteile Part set for air tank, nozzle parts	126599	6
17	TS-Bremsbacke Part set brake shoes	126600	7
18	Lokgrundrahmen Loco basic frame	129030	16
19	Lokplatine kpl. Printed circuit board assembly for loco	126607	27
20	TS-Federn für Lok u. Tender Part set springs for loco a. tender	126616	9
21	Haftringsatz 10Stk. Set w. traction tyres 10pieces	129040	10
22	SK-Schraube M1,6x3 SK-Screw M1,6x3	125023	3
23	TS-Steuerungsträger Part set reversing gear support	126831	9

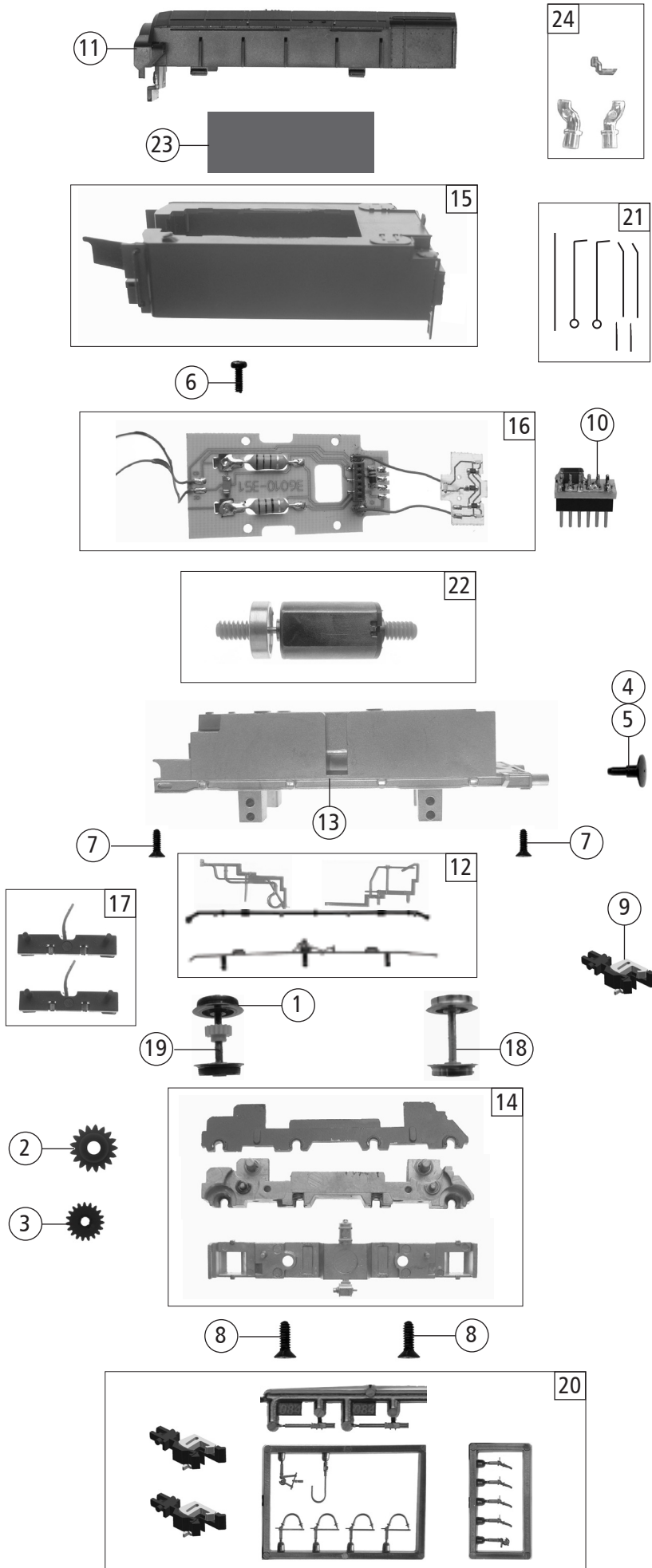

36020		DR	BR 44	=	
Pos. Nr. Pos.no.	Beschreibung Description	Art.-Nr. Art.no.	Preisgruppe Price bracket		
1	Hafringsatz 10Stk. 7,8mm Set with traction tyres 10pieces 7,8mm	85617	10		
2	Schnecken Zahnrad Z=22/12 Worm gear wheel Z=22/12	86482	4		
3	Zahnrad Z=19 Gear wheel Z=19	86499	3		
4	Puffer flach Buffer, flat	107658	5		
5	Puffer gewölbt Buffer, curved	107659	5		
6	GF-Schraube M1,6x4 mm Self-tapping screw M1,6x4 mm	114850	3		
7	SK-Schraube M1,6x5 mm SK-Screw M1,6x5 mm	115317	4		
8	Schraube M2x8 mm Screw M2x8 mm	120189	3		
9	TT-Kupplung TT-Coupling	131014	8		
10	Brückenbaugruppe Connector	126404	9		
11	Tender Ölaufsatz Oil tender elevation	129033	9		
12	TS-Tender-Führerhausleitungen Part set for tender and wires for driver's cab	126595	6		
13	Tendergrundrahmen Tender basic frame	129034	12		
14	Getriebeatz Gear set	126603	11		
15	Tendergehäuse kpl. Betr.nr. 44 0296-2 Tender body ass loco no 44 0296-2	139997	27		
16	Tenderplatine kpl. Printed circuit board assembly for tender	126620	25		
17	Tenderkontakthalter kpl. Tender contact holder ass.	126621	8		
18	Radsatz o. Haftring o. Zahnrad Wheelset w/o gear wheel w/o traction tyres	126623	10		
19	Radsatz m. Haftring m. Zahnrad Wheelset with gear wheel with traction tyres	126624	12		
20	Zurüstbeutel Bag with accessories	126630	10		
21	TS - Tendergriffstangen+Federn Part set handles	126631	10		
22	Motor Motor	126622	28		
23	Schaumstoff für Schalldämmung Foam for sound insulation	126838	4		
24	TS-Lichtleiter Part set light conductor	129032	13		